



FOLDING AXLE STANDS (PAIR) 2 TONNE CAPACITY PER STAND

MODEL NO: **AS2000F.V2**

Thank you for purchasing a Sealey product. Manufactured to a high standard, this product will, if used according to these instructions, and properly maintained, give you years of trouble free performance.

IMPORTANT: PLEASE READ THESE INSTRUCTIONS CAREFULLY. NOTE THE SAFE OPERATIONAL REQUIREMENTS, WARNINGS & CAUTIONS. USE THE PRODUCT CORRECTLY AND WITH CARE FOR THE PURPOSE FOR WHICH IT IS INTENDED. FAILURE TO DO SO MAY CAUSE DAMAGE AND/OR PERSONAL INJURY AND WILL INVALIDATE THE WARRANTY. KEEP THESE INSTRUCTIONS SAFE FOR FUTURE USE.



Refer to Instructions

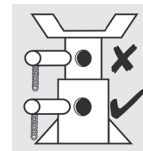

Fit pin through both the stand collar and the centre tube

1. SAFETY

WARNING!

DO NOT OVERLOAD AXLE STANDS BEYOND RATED CAPACITY. OVERLOADING CAN CAUSE DAMAGE TO, OR FAILURE OF, THE AXLE STANDS. POSITION LOAD ON CENTRE OF CRUTCH/SADDLE ONLY. ALWAYS USE STANDS IN PAIRS ON HARD LEVEL SURFACE CAPABLE OF SUSTAINING THE LOAD. USE OF STANDS ON OTHER THAN HARD LEVEL SURFACES CAN RESULT IN LOAD INSTABILITY AND POSSIBLE LOSS OF LOAD. DO NOT USE ON TARMACADAM. FAILURE TO FOLLOW THESE INSTRUCTIONS MAY RESULT IN DAMAGE TO AXLE STANDS, LOSS OF LOAD RESULTING IN PROPERTY DAMAGE, SERIOUS PERSONAL INJURY OR LOSS OF LIFE.

DANGER! GREAT CARE MUST BE TAKEN TO ENSURE YOU LOWER THE VEHICLE (OR OTHER LOAD) SLOWLY AND CAREFULLY ONTO THE CENTRES OF THE CRUTCH/SADDLE OF THE AXLE STANDS.

- ✓ Use only as specified by the manufacturer.
- ✓ Ensure the load does not exceed the maximum capacity as marked on the axle stand, per pair.
- ✓ Use no more than a single pair of stands either on the front, rear or one side of the vehicle. Use in pairs.
- ✓ No alterations or modifications shall be made to this product.
- ✓ Use on a hard, level surface, e.g. concrete. **DO NOT** use on uneven ground or tarmacadam.
- ✓ Securely chock wheels in contact with the ground. Before jacking and placing the stands, apply vehicle handbrake (put automatics in 'Park').
- ✓ Make sure that each stand is securely located under a strong point on the vehicle; consult the vehicle manufacturer's handbook for guidance. Ensure that height adjust locking mechanism is fully located before applying any load to the axle stand.
- ✓ Ensure that the load is located centrally on the saddle, and that the weight is directed through the vertical axis of the stand.
- ✓ Exercise extra care when using with a three wheeled vehicle or a trailer. Refer to vehicle manufacturer's instructions.
- ✓ Once vehicle is supported, ensure that the vehicle and stands are stable before starting work. Ensure that it is not possible for the vehicle to move before commencing any work.
- ✓ Inspect stands before each use. **DO NOT** use if they show signs of damage. **DO NOT** use if it is suspected that they have been overloaded.
- ✓ Before commencing any work or going beneath the vehicle, undertake a risk assessment. Ensure that a responsible person is aware of the work about to be undertaken.
- ✓ Replace any labels on the axle stand should they become unreadable. This applies in particular to any warning or operation instruction labels. If replacement labels are required, contact your Sealey stockist.
- ✗ **DO NOT** use axle stands on the highway, or anywhere else if it is deemed to be unsafe.
- ✗ **DO NOT** push or twist the vehicle/load whilst it is supported on stands.
- ✗ **DO NOT** mix components between stands. Use only as supplied.
- ✗ **DO NOT** allow children or animals in the vicinity of a vehicle supported on axle stands.
- ✗ **DO NOT** leave a vehicle on axle stands in an area that could be considered a hazard to others or property.
- ✓ **FOLLOW STEPS 1, 2, AND 3 TO CORRECTLY PLACE VEHICLE / LOAD ONTO AXLE STANDS.**

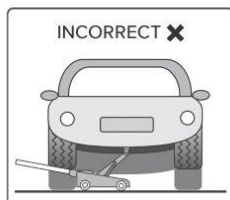
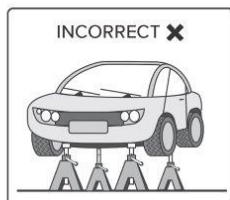
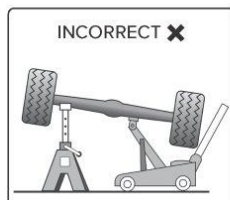
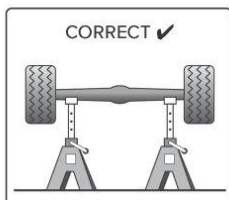
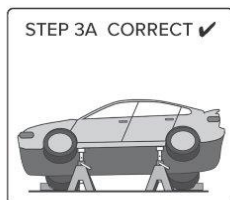
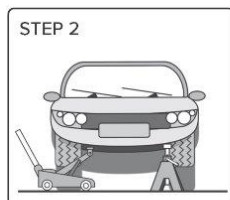
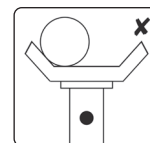
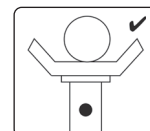

2. INTRODUCTION

Folding design saves space and makes these axle stands ideal for occasional use. Welded steel construction for increased strength and safety. Folding design for space efficient storage. Fitted with double-locking safety pin. Sold in pairs.

3. SPECIFICATION

Model No:..... **AS2000F.V2**
Capacity Each: 2tonne (2,000 kg)
Capacity Pair: 4tonne (4,000 kg)
Minimum Working Height: 278mm
Maximum Working Height 366mm

4. OPERATION

- 4.1. Familiarise yourself with the product. Check that the stands are in good order and condition and that no damaged has been sustained during transit. Familiarise yourself with the folding mechanism (fig. 1.1) and the extending legs (fig.1.2). Insert the centre column (fig.1.3) in the stand collar (fig.1.4), adjust to height required and insert the locking pin (fig.1.5). Ensure the maximum load does not exceed 4 tonnes per pair of axle stands, (2 tonnes for each stand).
- 4.2. Refer to vehicle owners hand book for correct jacking procedure. Check to ensure that manufacturers recommended jacking points are in good condition.
- 4.3. Ensure the vehicle brake is on (or in parked mode) and wheels are chocked.
- 4.4. Ensure the stand legs are fully extended and adjust height of stand to correspond with the raised vehicle.
- 4.5. Check that the locking pin is correctly pushed all the way through the stand collar, centre column and out of the other side, insert safety pin, then position stands under vehicle at points specified by vehicle manufacturer.
- 4.6. Carefully and slowly lower the load onto stands. Ensure the load bearing points sit in the center of the stand saddle and check that the stands are stable and not leaning. Also ensure that there are no objects or persons that could impede the safe lowering of the vehicle onto the stands.
- 4.7. After use, hold the centre column (fig.1.3) firmly when removing the locking pin (fig.1.5). Failure to do so will allow the center column to fall freely through the main center tube which could be dangerous.
 - WARNING!** Ensure you follow all instructions carefully. Failure to note these warnings may cause damage, serious injury or loss of life.

5. MAINTENANCE

- 5.1. Before each use check to ensure stands and stand welds are not cracked, and that there are no missing and/or damaged parts.
 - WARNING!** Any stand that appears to be damaged in any way must be removed from service immediately.
- 5.2. Ensure the locking pin, folding arms and mechanism are in good order and condition.
- 5.3. Due to the potential hazards associated with these stands, do not misuse, or make any modification to the stands or components.
- 5.4. It is the responsibility of the stands owner to ensure the operator has read these instructions, and that the operator is familiar with the stands use and limitations.

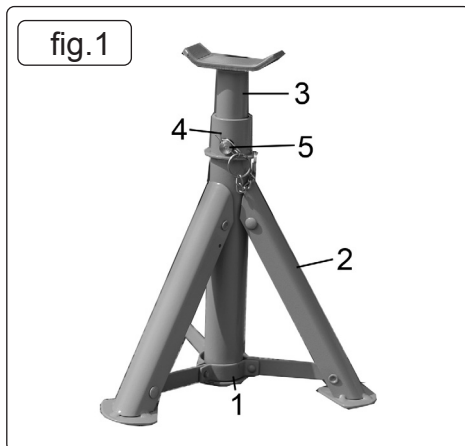

ENVIRONMENT PROTECTION

Recycle unwanted materials instead of disposing of them as waste. All tools, accessories and packaging should be sorted, taken to a recycling centre and disposed of in a manner which is compatible with the environment. When the product becomes completely unserviceable and requires disposal, drain any fluids (if applicable) into approved containers and dispose of the product and fluids according to local regulations.

Note: It is our policy to continually improve products and as such we reserve the right to alter data, specifications and component parts without prior notice. Please note that other versions of this product are available. If you require documentation for alternative versions, please email or call our technical team on technical@sealey.co.uk or 01284 757505.

Important: No Liability is accepted for incorrect use of this product.

Warranty: Guarantee is 12 months from purchase date, proof of which is required for any claim.

Sealey Group, Kempson Way, Suffolk Business Park, Bury St Edmunds, Suffolk. IP32 7AR



01284 757500



01284 703534



sales@sealey.co.uk



www.sealey.co.uk